

Standard Rectifier Module

1~ Rectifier	
V_{RRM}	= 800 V
I_{DAV}	= 125 A
I_{FSM}	= 1800 A

1~ Rectifier Bridge

Part number

VBO125-08NO7

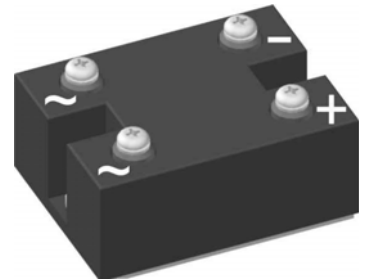

 E72873

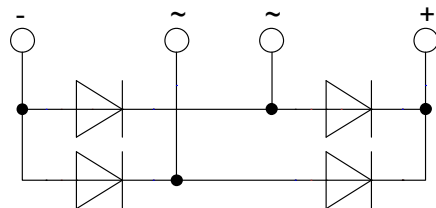

Features / Advantages:

- Package with DCB ceramic
- Improved temperature and power cycling
- Planar passivated chips
- Very low forward voltage drop
- Very low leakage current

Applications:

- Diode for main rectification
- For one phase bridge configurations
- Supplies for DC power equipment
- Input rectifiers for PWM inverter
- Battery DC power supplies
- Field supply for DC motors

Package: PWS-C

- Industry standard outline
- RoHS compliant
- Easy to mount with two screws
- Base plate: Copper internally DCB isolated
- Advanced power cycling

Rectifier				Ratings				
Symbol	Definition	Conditions		min.	typ.	max.	Unit	
V_{RSM}	max. non-repetitive reverse blocking voltage					900	V	
V_{RRM}	max. repetitive reverse blocking voltage					800	V	
I_R	reverse current	$V_R = 800$ V	$T_{VJ} = 25^\circ\text{C}$			200	μA	
		$V_R = 800$ V	$T_{VJ} = 150^\circ\text{C}$			2	mA	
V_F	forward voltage drop	$I_F = 50$ A	$T_{VJ} = 25^\circ\text{C}$			1.07	V	
						1.21	V	
		$I_F = 100$ A	$T_{VJ} = 125^\circ\text{C}$			0.97	V	
						1.15	V	
I_{DAV}	bridge output current	$T_C = 105^\circ\text{C}$ rectangular	$T_{VJ} = 150^\circ\text{C}$			125	A	
								d = 0.5
V_{FO}	threshold voltage					0.76	V	
r_F	slope resistance					3.6	m Ω	
R_{thJC}	thermal resistance junction to case					0.6	K/W	
R_{thCH}	thermal resistance case to heatsink				0.3		K/W	
P_{tot}	total power dissipation			$T_C = 25^\circ\text{C}$		205	W	
I_{FSM}	max. forward surge current	t = 10 ms; (50 Hz), sine	$T_{VJ} = 45^\circ\text{C}$			1.80	kA	
								t = 8,3 ms; (60 Hz), sine
		t = 10 ms; (50 Hz), sine	$T_{VJ} = 150^\circ\text{C}$				1.53	kA
I^2t	value for fusing	t = 10 ms; (50 Hz), sine	$T_{VJ} = 45^\circ\text{C}$			16.2	kA ² s	
								t = 8,3 ms; (60 Hz), sine
		t = 10 ms; (50 Hz), sine	$T_{VJ} = 150^\circ\text{C}$				11.7	kA ² s
C_J	junction capacitance	$V_R = 400$ V; f = 1 MHz		$T_{VJ} = 25^\circ\text{C}$		58	pF	

Package PWS-C			Ratings			
Symbol	Definition	Conditions	min.	typ.	max.	Unit
I_{RMS}	RMS current	per terminal			150	A
T_{stg}	storage temperature		-40		125	°C
T_{VJ}	virtual junction temperature		-40		150	°C
Weight				237		g
M_D	mounting torque		4.25		5.75	Nm
M_T	terminal torque		4.25		5.75	Nm
$d_{Spp/App}$	creepage distance on surface striking distance through air	terminal to terminal	26.0			mm
$d_{Spb/Apb}$		terminal to backside	14.0			mm
V_{ISOL}	isolation voltage	t = 1 second	3000			V
		t = 1 minute	2500			V
		50/60 Hz, RMS; $I_{ISOL} \leq 1$ mA				

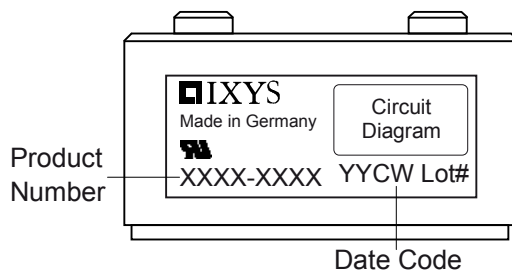

Ordering	Part Number	Marking on Product	Delivery Mode	Quantity	Code No.
Standard	VBO125-08NO7	VBO125-08NO7	Box	10	485136

Equivalent Circuits for Simulation

* on die level

$T_{VJ} = 150^\circ\text{C}$

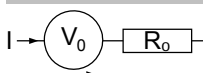

Rectifier

$V_{0\ max}$	threshold voltage	0.76	V
$R_{0\ max}$	slope resistance *	3.6	mΩ

Outlines PWS-C

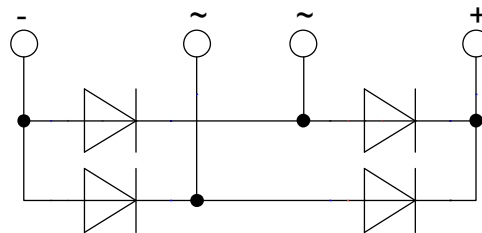
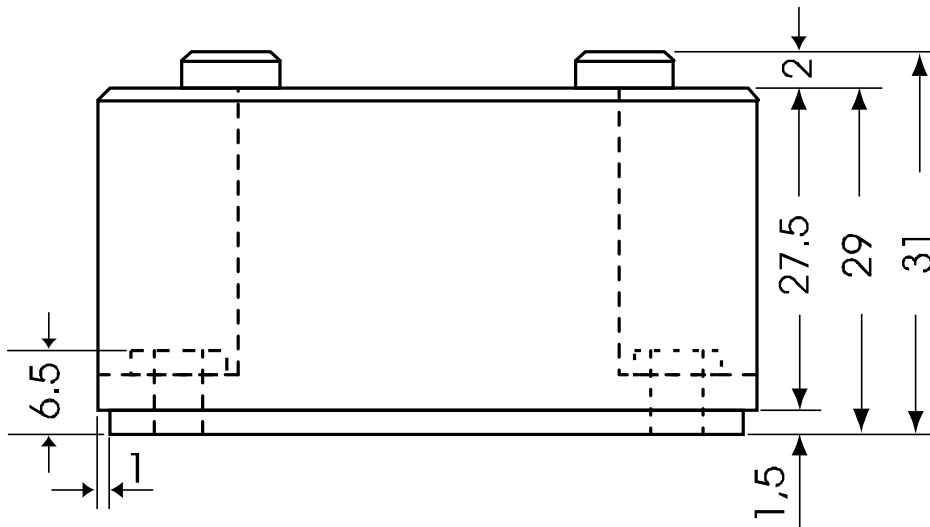
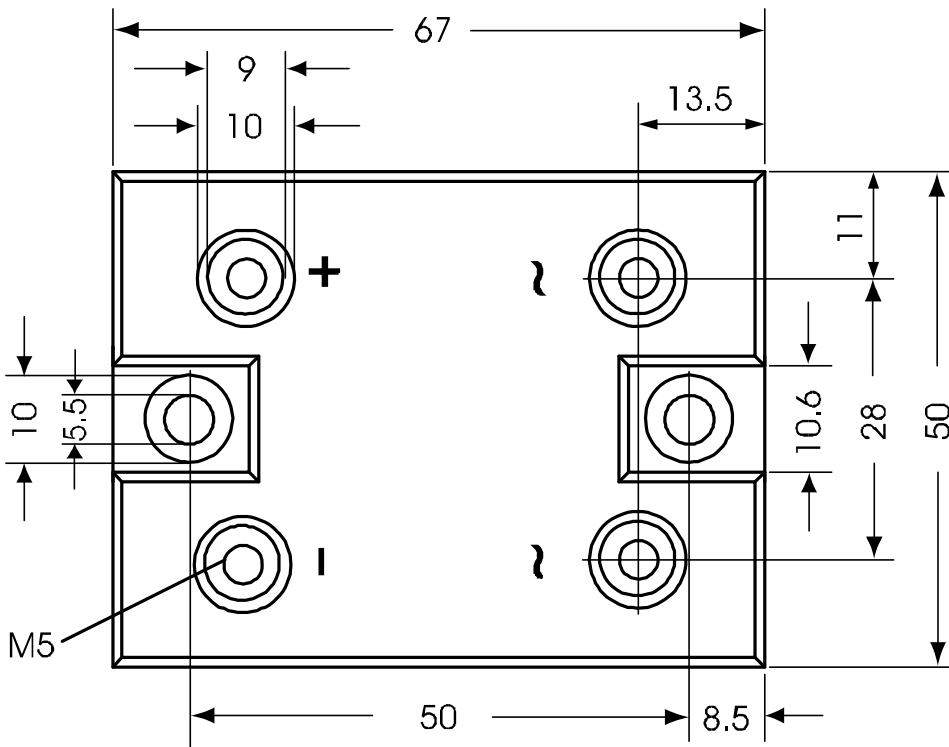

Rectifier

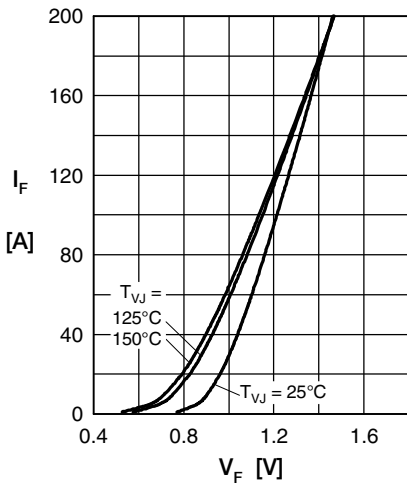

Fig. 1 Forward current versus voltage drop per diode

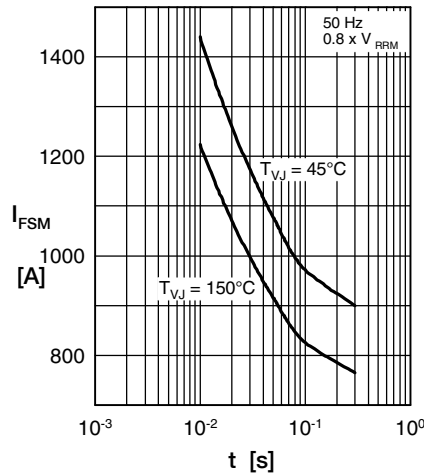

Fig. 2 Surge overload current vs. time per diode

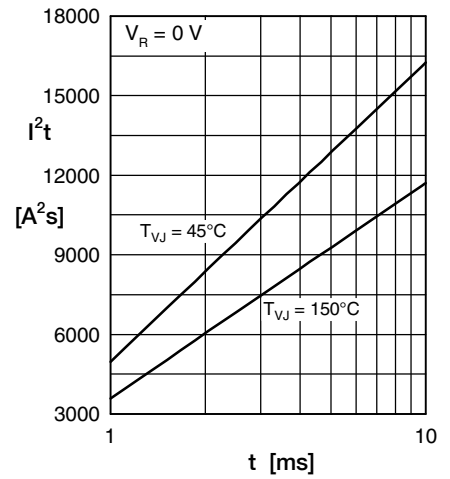

Fig. 3 I^2t versus time per diode

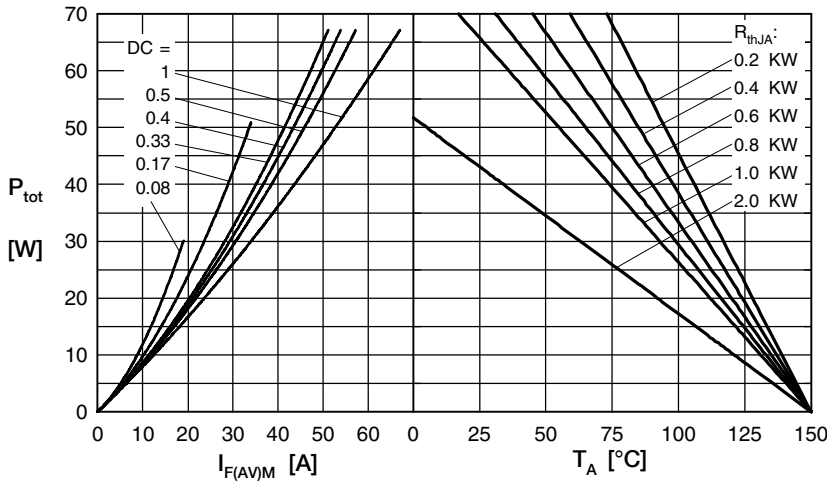

Fig. 4 Power dissipation vs. forward current and ambient temperature per diode

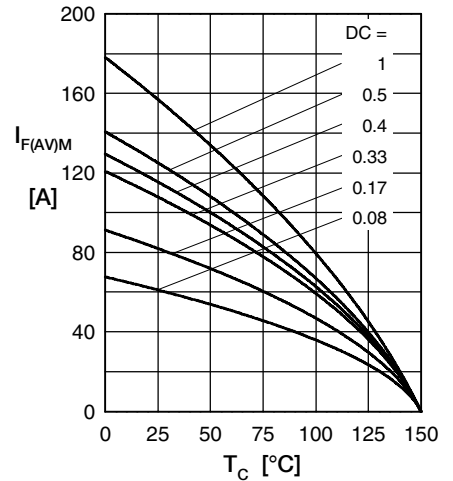

Fig. 5 Max. forward current vs. case temperature per diode

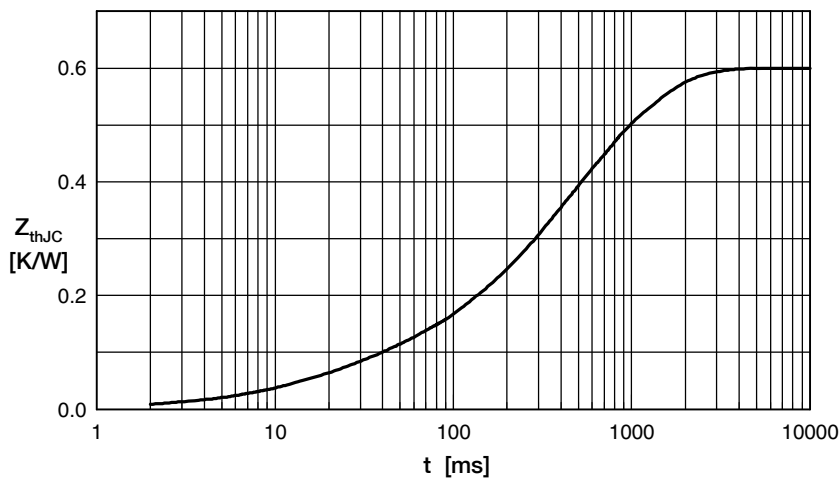

Fig. 6 Transient thermal impedance junction to case vs. time per diode

Constants for Z_{thJC} calculation:

i	R_{th} (K/W)	t_i (s)
1	0.060	0.020
2	0.003	0.010
3	0.150	0.225
4	0.243	0.800
5	0.144	0.580